

University of Colorado

Office of the President

University Information Systems

Leadership Team

Milap Sharma, Director Enterprise Development
Aaron Mansfield, Director UIS Service Management
Tony Brooks, Director ECS
Bryn Samuelson, Director Business Operations
Ridawn Cummings, Director PMO
Rana Silver, Director Student Systems
Brad Judy, Director IT Security
Jill Ibeck, Director HCM Systems

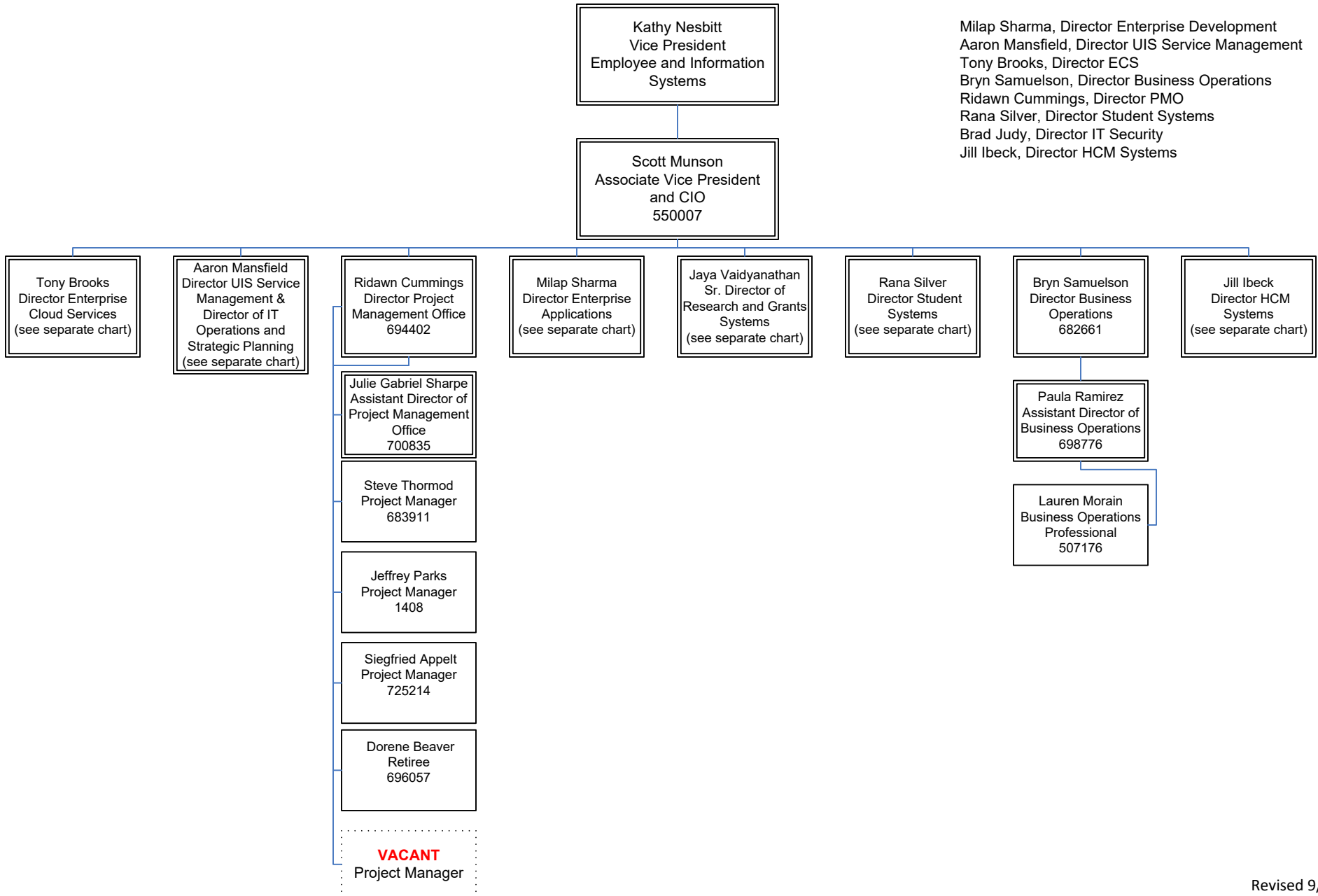

University of Colorado

Office of the President
University Information Systems

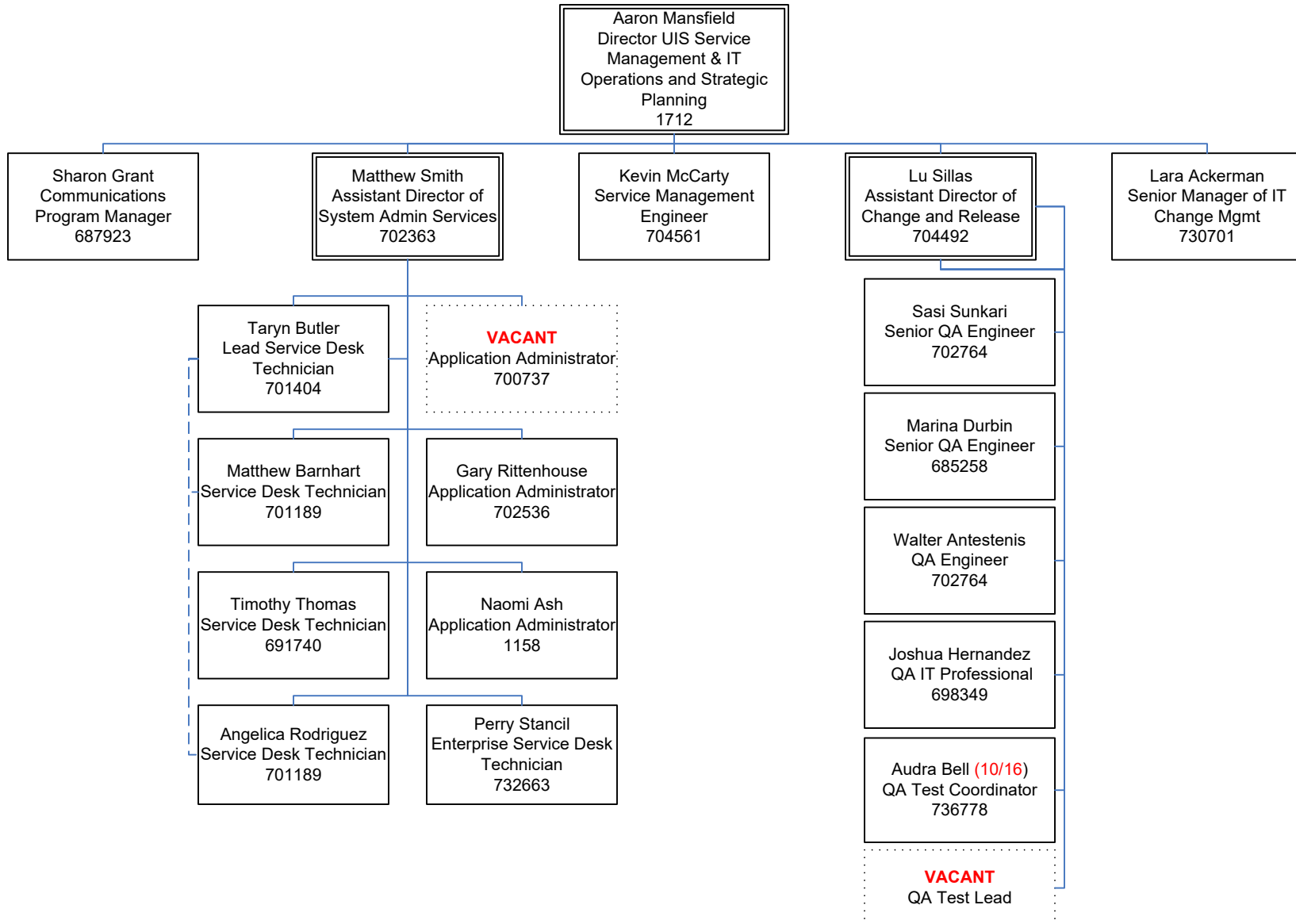

University of Colorado

Office of the President
University Information Systems

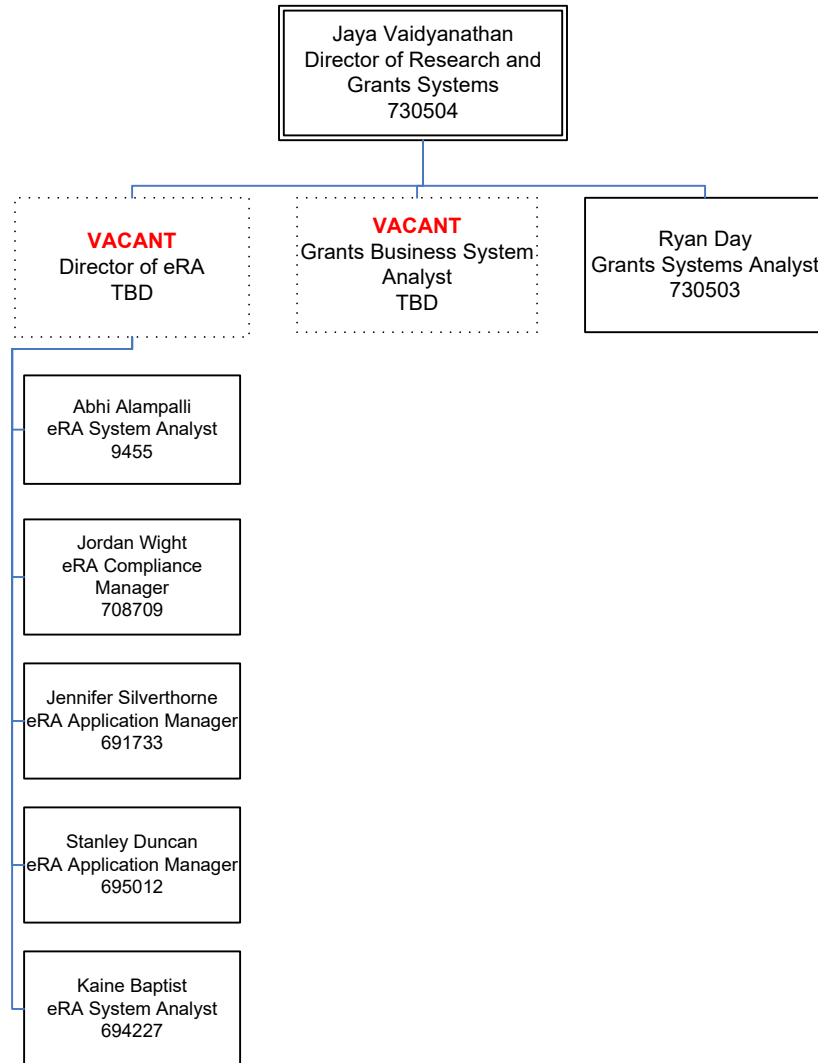

University of Colorado

Office of the President

University Information Systems

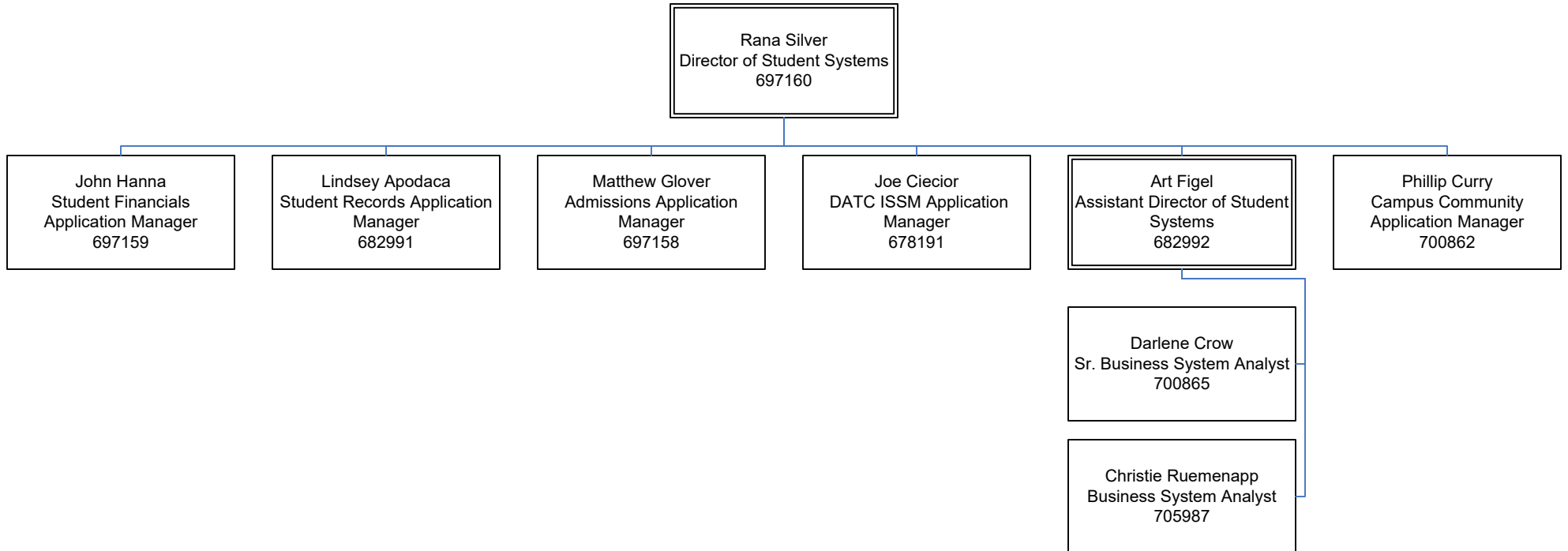

University of Colorado

Office of the President

University Information Systems

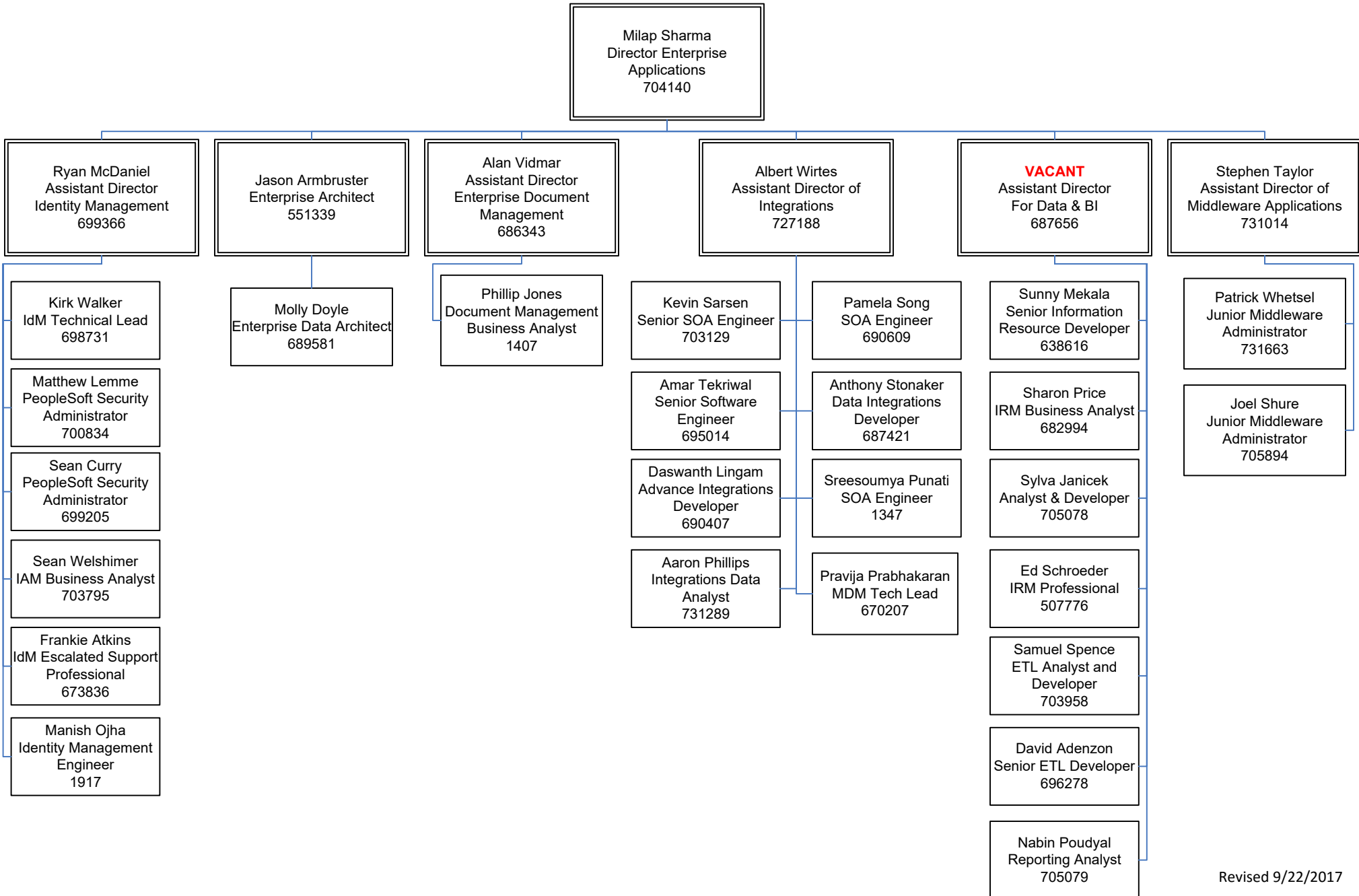

University of Colorado

Office of the President
University Information Systems

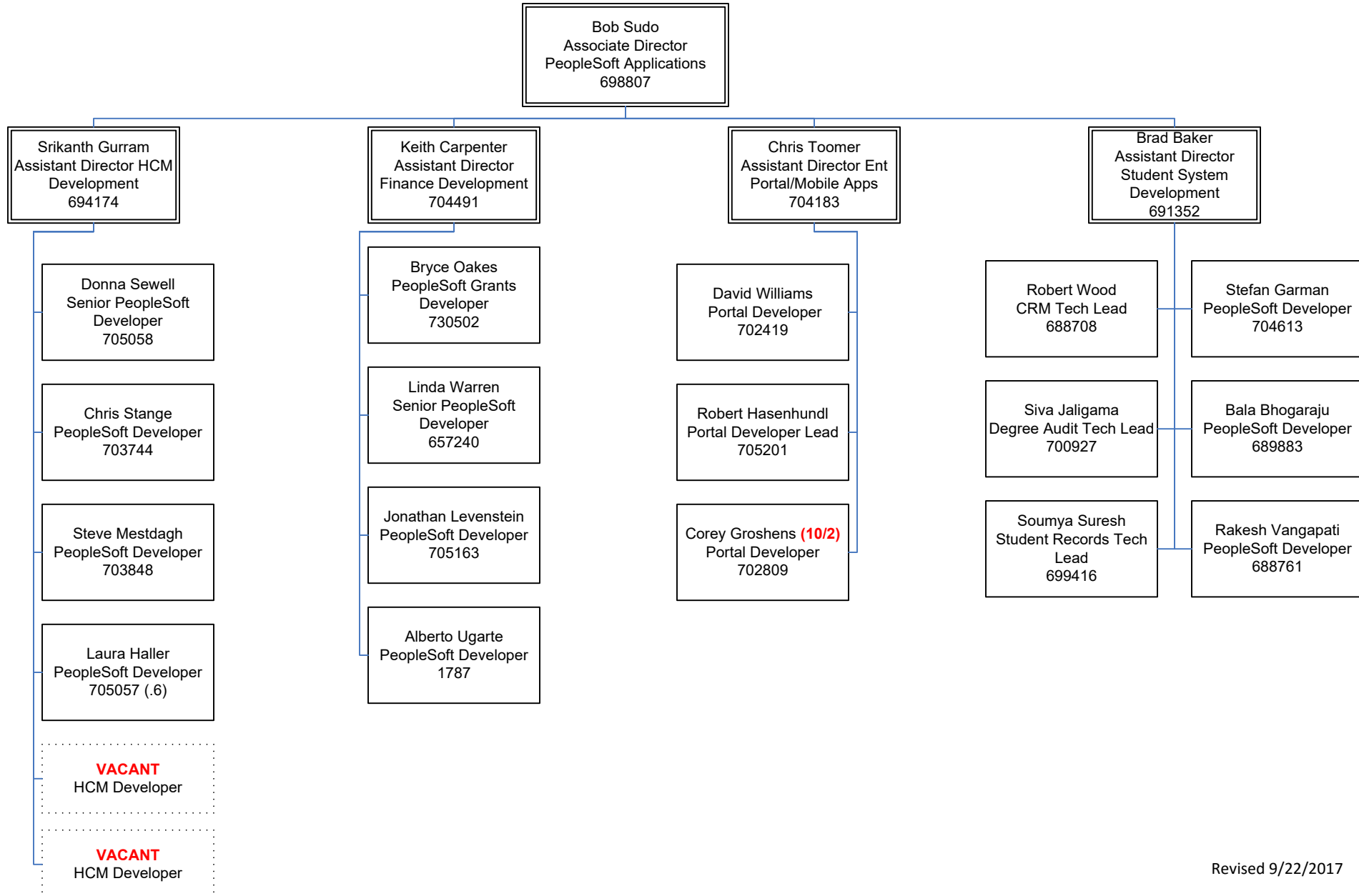

University of Colorado

Office of the President
University Information Systems

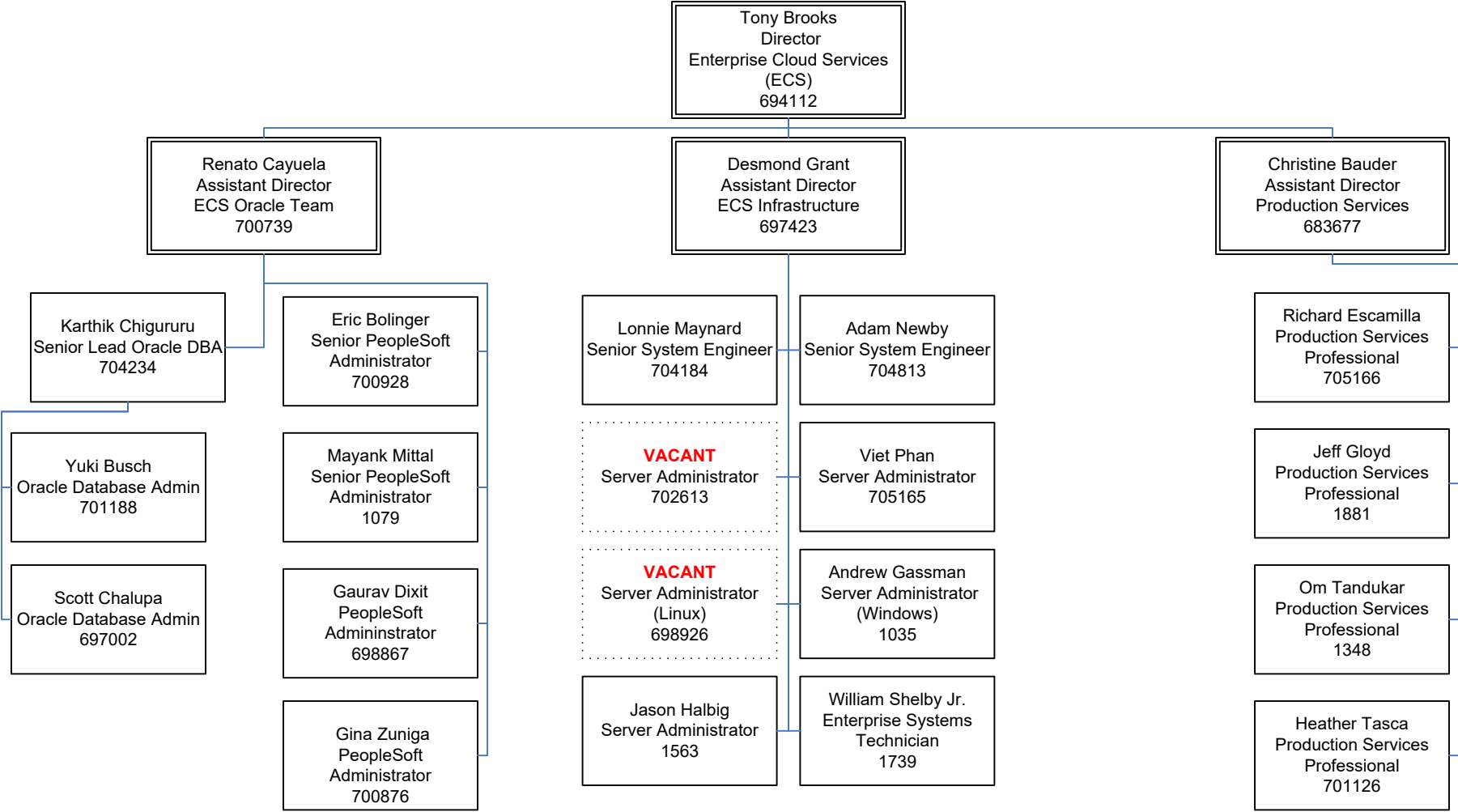

University of Colorado

Office of the President
University Information Systems

